



# Quick Installation Guide

Mega Series KSY -60KW-80KW

Poonam petrol pump, KSolare Technology Park, Sr.No. 62,  
Hissa No.03, Mangdewadi, Pune, Maharashtra 411046

Enquiry Email: [Sales@ksolare.com](mailto:Sales@ksolare.com)

Service Email: [service@ksolare.com](mailto:service@ksolare.com)

**Contact: 8530111222**

Follow Us On





**5G Mega Series**  
**60KSY, 60KSY ,**  
**70KSY, 70KSY ,**  
**75KSY, 80KSY**  
**String Type PV Inverter**  
**Quick Installation Guide**

- The contents of this manual are subject to irregular updates due to product upgrades or other reasons. Unless otherwise agreed, this manual is only used as guidance. All statements, information and recommendations in the document do not constitute any express or implied warranty.
- In any case, guidance in this manual cannot replace safety warnings and instructions on user manuals and product fuselage.
- All operations of the equipment must be carried out by professionals. Operators should be fully familiar with the composition, working principles and standards of the whole PV system.
- Before installing the equipment, check whether the delivery is complete and whether the body has obvious external damage according to the "packing list". If there are any missing items or any damage, please contact the distributor.
- The following two situations occur and are not covered by the warranty.
  - Remove the tamper-evident label;
  - Equipment damage caused by failure to store, handle, install, and use the equipment in accordance with the requirements of this manual and the user manual.

## 1. Product Introduction

### Scope of Supply



\*The hanging plate is fixed on the back of inverter.

The documents including:

*Quick Installation Guide* (this manual)

*List of Accessories*

*Inspection Report*

*Certification*

For the model and number of the accessories, please refer to the *List of Accessories*.

This figure is only for reference; please refer to the actual product.

### Inverter Front

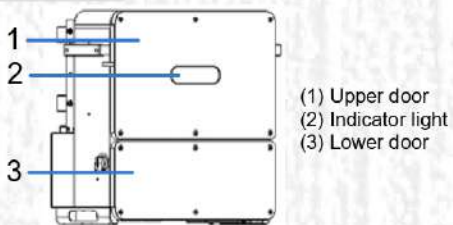

- Upper door
- Indicator light
- Lower door

### Port Description

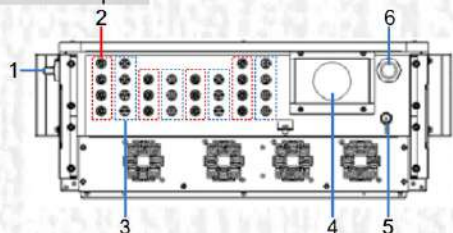

- DC SWITCH
- PV+ terminals
- PV- terminals
- AC output terminal
- Wi-Fi/GPRS interface
- RS485 interface

## 2. Installation Requirements

### Installation Environment

Please install the inverter in a well ventilated environment, avoid direct sunlight, rain and snow.

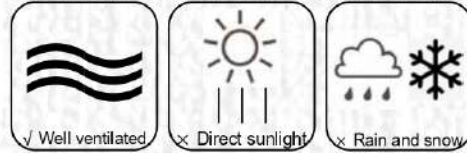

Ambient Temperature

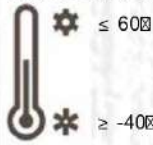

Relative humidity



(The inverter can reach the best working condition when the temperature is lower than 40°C )

### Inverter and hanging plate size

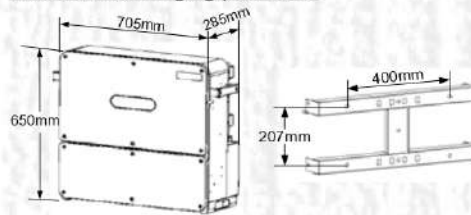

### Installation Space

The installation space of single inverter is as following:

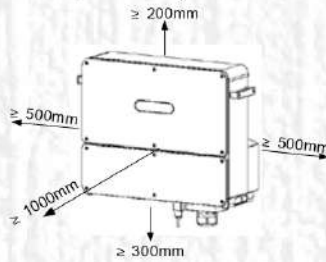

When installing multiple string inverters in a same surface, the side by side installation is recommended.



When installing multiple string inverters in two lines, the triangle installation is recommended.

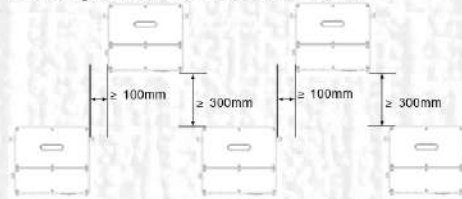

Please install it vertically or tilt it backward at most 15° to facilitate the heat dissipation of the inverter. Do not install the inverter at an angle (forward, backward, or sideways), horizontally, or upside down.

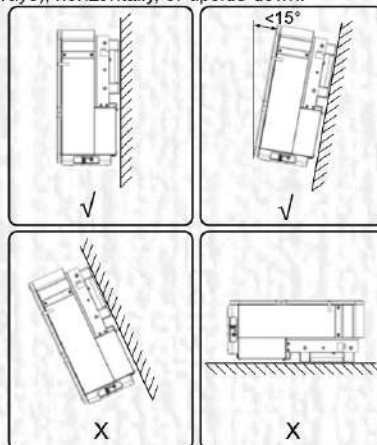

## 3. Inverter Installation

### Installation Steps

1. Unscrew the 4 fixing screws and keep them in a safe place, and then take out the hanging plate.

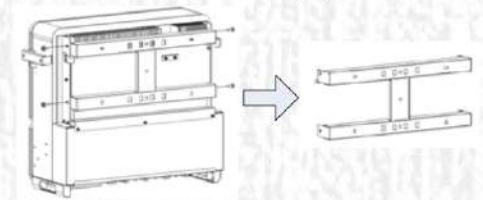

2. According to the installation environment, choose a suitable installation method to install the hanging plate.

#### Wall/Bracket Mounting

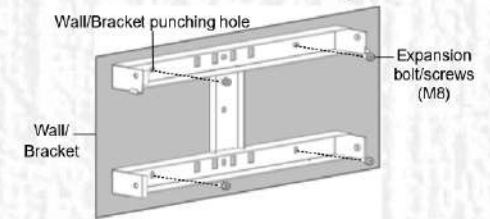

#### Screw Rod Mounting

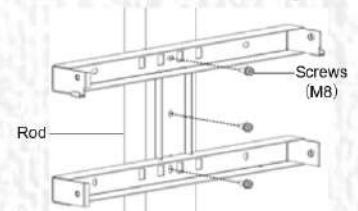

#### Hoop Rod Mounting

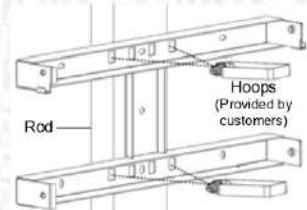

3. Hang the inverter on the hanging plate.



4. Reinstall the 4 fixing screws removed in the first step.

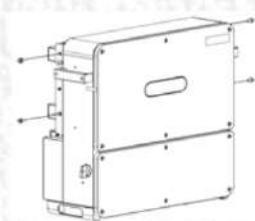

## 4. Electrical Connections



- When connecting cables, do not operate live and follow the relevant requirements in the Inverter's *User Manual*.
- Before connecting the cable, please complete the following preparations so as not to cause bodily injury.
  - Disconnect the inverter DC switch. Ensure that the inverter is in shutdown state and attach warning signs.
  - Confirm the positive and negative pole of the input cable and mark it well. Make sure the connection between input cable and PV cluster is broken.
  - It is confirmed that the open circuit voltage of PV cluster does not exceed the specified limit.
  - Confirm that the corresponding AC box circuit breaker is in a state of disconnection.
- When connecting the input cable, ensure that the positive and negative poles of the input cable correspond to the positive and negative poles of the PV terminals of the series inverter.

## ☒ Cable Selection

Name	Recommended Cable Specifications
PV branch input cable	Industry general PV cable, model: PV1-F It is recommended to use a cable with a cross-section of 4.0 mm <sup>2</sup> for each PV+ and PV- branch.
AC output cable	4 core outdoor cable (A, B, C, N) or 3 core outdoor cable (A, B, C) Recommended cross sectional area of conductor (copper): 35mm <sup>2</sup>
RS485 communication cable	It is recommended to use a special communication cable or 4-core or 2-core shielded twisted pair cable with a cross-sectional area of not less than 0.75mm <sup>2</sup> .
PE ground cable	It is recommended to use at least one grounded dedicated cable with a cross-sectional area of 16 mm <sup>2</sup> .

### ☒ Note:

1. The AC output has only 1 waterproof lock with a specification of 42mm~50mm. When the screw is locked, use the sleeve to calibration.
2. The RS485 communication cable has only one waterproof lock and the size is 18mm~25mm.

## ☒ Output side cable connection

1. Crimping the OT terminal. Users need to prepare the OT terminals themselves. The OT terminal model of PE is M6, and the model of AC is M8.

- 1) Strip the front end of the cable core.

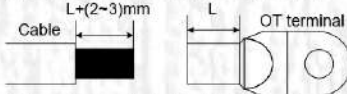

- 2) Put on the heat shrink tubing and OT terminal.

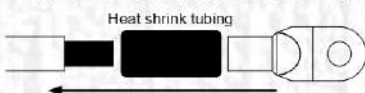

- 3) Crimp the OT terminal.

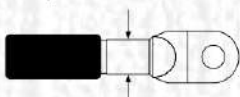

- 4) Move the heat shrink tubing forward to cover the seam.

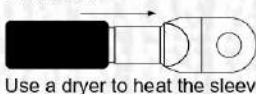

- 5) Use a dryer to heat the sleeve to make it tight.



2. Ground connection:

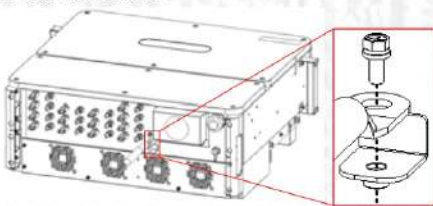

3. DC output cable connection :

- 1) Remove the lower door by 4# Allen wrench.

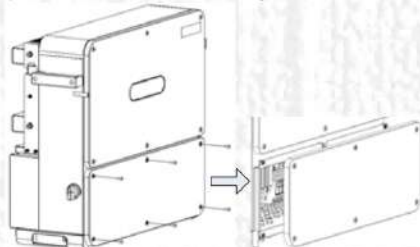

- 2) Tear off the AC output protective film and install the waterproof lock.

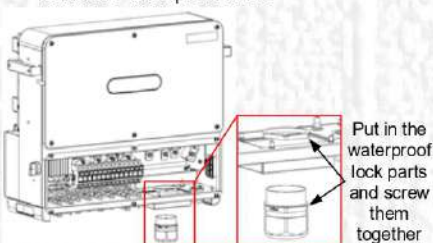

- 3) Screw off the locking cap of the AC output waterproof lock.
- 4) The AC cables are connected to A, B, C and N of the AC terminal row in turn, and the fastening torque is 8N\*m. Fasten the locking cap after completion.

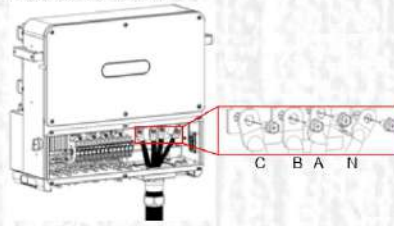

## ☒ PV Input Cable Connection

1. Crimp the MC4 terminal:

- 1) Confirm the positive and negative terminals of the input cable and mark them.

Note: Please do not judge by the color of the cable only, be sure to refer to the actual measurement.

- 2) Stripping with a wire stripper;

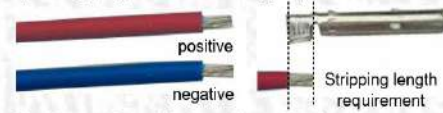

- 3) Press the cable together with the corresponding core according to the correct polarity.

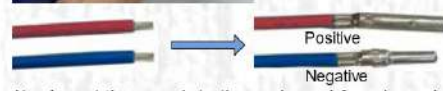

- 4) Insert the core into the male and female ends of the MC4 connector and tighten the connector back cover according to the correct polarity.

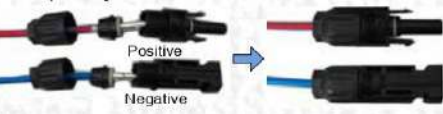

2. Remove the sealing plugs of the input terminals at the bottom of the inverter. Connect the positive and negative terminals of each input cable to the PV+ and PV- input terminals of the inverter one by one. Insert it until you hear a "click".

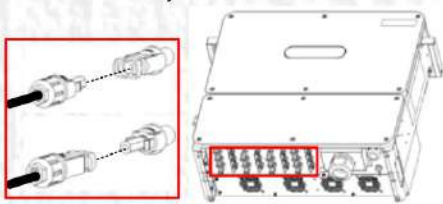

3. If there are unconnected input terminals, please confirm that the unconnected input terminals remain sealed by the plugs.

## ☒ RS485 Communication Cable Connection

On the RS485 adapter board X3, two RS485 interfaces (labeled P2, P3) are shown. This interface is used to connect adjacent inverters.

1. Crimp the 485 terminal. Users need to prepare the terminals themselves, and the terminals model needs to match the 485 cable selected.

- 1) Strip the front end of the cable core.

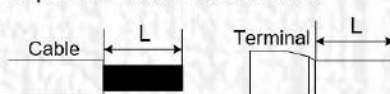

- 2) Insert the terminal and crimp.

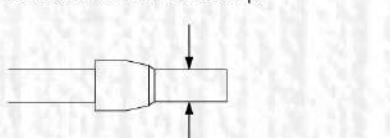

2. Unscrew the RS485 waterproof lock and take off the seal baffle.

3. Pass the RS485 cable through the waterproof lock and connect it to the interface P2, P3 on the RS485 adapter board X3. Tighten the locking cap after completion.

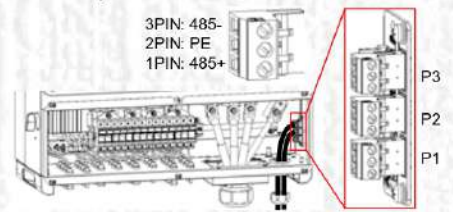

4. Reinstall the lower door panel of the inverter.

The connection of multiple inverters is suggested to be connected in series in the following diagram.

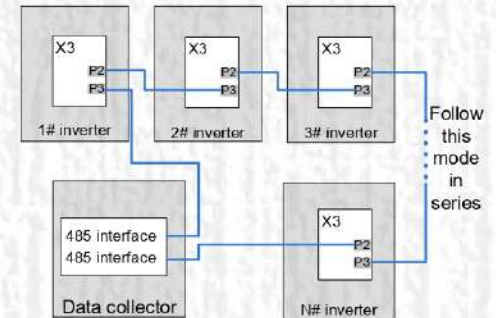

## 5. Post-installation Check

1. Confirm that the inverter is securely installed in place	☒
2. Check if the ground wire is properly connected, whether the connection is reliable and secure, and ensure that there is no open-circuit or short-circuit	☒
3. Check that the output cable is properly connected, that the connection is reliable and secure, and that there is no open-circuit or short-circuit.	☒
4. Check whether the DC input cable connection polarity is correct, whether the connection is reliable and secure, and ensure that there is no open-circuit or short-circuit.	☒
5. Check if the RS485 communication cable connection is correct and reliable.	☒
6. Check if the inverter's lower door panel is replaced and the door panel screws are tightened.	☒
7. Check if the DC input terminals that are not needed are sealed	☒

## 6. LED indicators Description

Indicator	Status	Meaning
POWER	Light on	Both PV side and grid side are normal
	Light flash	Grid side is normal, PV side is abnormal
	Light slow flash	PV side is normal, grid side is not connected
	Light off	Both PV side and grid side are not connected
RUN	Light on	Inverter is in operation
	Light off	Inverter is not in operation
COM.	Light slow flash	Communication is normal
	Light off	Communication is abnormal
ALARM	Light slow flash	Prompt warning
	Light flash	Abnormal warning
	Light on	Fatal warning

Note:  
Slow flash: 1 sec on, 2 sec off;  
Flash: 0.5 sec on, 0.5 sec off.

## Ksolare Energy Private Ltd.

Factory & Marketing Office  
Ksolare Technology Park Sr.No.62,  
Hissa No.03, Mangdewadi, Pune-Satara  
Road, Katraj, Pune-411046. (MH-India)

Sales: 7888009284/85/86

Service: 8530111222

Email: sales@ksolare.com

www.ksolare.com



Poonam petrol pump, KSolare Technology Park, Sr.No. 62,  
Hissa No.03, Mangdewadi, Pune, Maharashtra 411046

Enquiry Email: [Sales@ksolare.com](mailto:Sales@ksolare.com)

Service Email: [service@ksolare.com](mailto:service@ksolare.com)

**Contact: 853011222**

**Follow Us On**

